

# Quick Start and Safety Manual

## impression<sup>®</sup> X5 IP Bar 1000



Software v.1.1.3  
Rev. 20230928-01



## Document revisions

<b>Revision number</b>	<b>Notes</b>	<b>Date released</b>
20230928-01	Minor corrections and improvements to document	October 2023
20230815-01	First release of the Quick Start and Safety Manual for the impression X5 IP Bar 1000. Covers firmware v. 1.1.3	August 2023

GLP® impression X5 IP Bar 1000 Quick Start and Safety Manual – Revision 20230815-01

---

© 2023 German Light Products GmbH. All rights reserved.

The marks 'GLP' and 'German Light Products' are trademarks registered as the property of German Light Products GmbH in Germany, in the United States of America and in other countries.

The information contained in this document is subject to change without notice. German Light Products GmbH and all affiliated companies disclaim liability for any injury, damage, direct or indirect loss, consequential or economic loss or any other loss occasioned by the use of, inability to use or reliance on the information contained in this document.

Manufacturer head office:

German Light Products GmbH (GLP), Industriestrasse 2, 76307 Karlsbad, Germany  
Tel (Germany): +49 7248 92719 - 0

Service & Support EMEA:

GLP, Industriestrasse 2, 76307 Karlsbad, Germany  
Tel. (Germany): +49 7248 9271955  
Email: support@glp.de  
www.glp.de

Service & Support USA:

GLP USA, 1145 Arroyo St., Ste. A, 91340 San Fernando, California  
Tel (USA): +1 818 767 8899  
Support (US): info@germanlightproducts.com  
www.germanlightproducts.com



## Table of Contents

1. Safety.....	5
Key to symbols .....	5
General safety information .....	5
Electrical safety .....	6
Fire safety and protection from burns.....	7
Eye safety .....	8
Strobe safety .....	8
Installation safety and protection from personal injury.....	9
2. Avoiding damage to the fixture .....	11
General precautions.....	11
Avoiding damage from light sources and heat.....	11
Avoiding damage from dust and airborne particles.....	12
Transportation and storage.....	12
3. Impression X5 IP Bar 1000 overview .....	13
4. Features .....	14
User Manual .....	14
Tilt lock.....	14
5. Installation.....	15
Mounting options.....	15
Securing the fixture with a safety cable.....	15
End-to-end alignment.....	16
Standing the fixture on a horizontal surface .....	16
Installing on a rigging truss or similar structure.....	16
6. AC mains power .....	18
Power cable .....	18
Connecting to power .....	18
Installing power connectors .....	18
Connecting multiple fixtures to power in a chain .....	19
7. Connecting to DMX data.....	20
8. Starting and stopping operation .....	21
Transportation and storage.....	21
9. Service .....	22
Installing optical accessories .....	22
Cleaning.....	22
GLP Service and Support .....	23
10. Technical specifications .....	24
11. Dimensions.....	27

## 1. Safety

### Key to symbols

The following symbols are used in this Guide:



**Warning!** Safety hazard. Risk of severe injury or death.



**Warning!** Hazardous voltage. Risk of lethal or severe electric shock.



**Warning!** See user manual for important safety information.



**Warning!** Fire hazard.



**Warning!** Risk of eye injury.

---



### General safety information

Read this manual carefully before installing, using or servicing the GLP impression X5 IP Bar 1000 lighting fixture.

If you have any doubts or questions about how to use the fixture safely, contact your GLP® supplier for assistance. Your GLP supplier will be happy to help.

The user documentation for the impression X5 IP Bar 1000 lighting fixture consists of:

- The **Quick Start and Safety Manual**, supplied with fixtures and available for download from [www.glp.de](http://www.glp.de). The Quick Start and Safety Manual contains important safety information and installation instructions that the installer and user must read.
- The **User Manual**, available for download from [www.glp.de](http://www.glp.de). The User Manual explains features and control options of fixtures.
- The **DMX Channel Index**, available for download from [www.glp.de](http://www.glp.de). The Channel Index is a separate guide to the DMX control channel layout and DMX commands available.

All documents are available for download from [www.glp.de](http://www.glp.de).

The impression X5 IP Bar 1000 is intended for use by experienced professionals with the knowledge and skills to set up, operate, and maintain high-powered, remotely controlled lighting equipment safely and efficiently. These operations require expertise that may not be provided in this Manual or in the User Manual.

- Respect all warnings and directions given in the fixture's user documentation and on the fixture. Read the user documentation and familiarize yourself with the safety precautions it contains before installing or using the fixture. GLP and affiliated companies will take no responsibility for damage or injury resulting from disregard for the information in the user documentation.
- Check the GLP website at [www.glp.de](http://www.glp.de) and make sure that you have the latest version of this manual. Check the fixture software version indicated on page 2 of this manual and then use the fixture's control panel to check the version installed in the fixture. If the versions are not the same, this manual may still cover the fixture, because software updates do not always affect the way you use the fixture. However, it is possible that this manual does not match the fixture perfectly. Software release notes can help clarify this question. You can consult software release notes and download the correct version of this manual on the GLP website if necessary.
- Make all user documentation – this Quick Start and Safety Manual as well as the User Manual – available to all installers and operators. Save both documents for future reference.
- If you have any questions about the safe operation of the fixture, please contact an authorized GLP distributor (see list of distributors at [www.glp.de](http://www.glp.de)).
- The fixture is not suitable for household use or for use in any location where unattended children have access to it.
- Use the fixture only as directed in this manual. Observe all markings in this manual and on the fixture.
- Refer any repairs and service operations that are not described in this manual to a technician authorized by GLP.
- The light source in this fixture must not be changed by the end user.
- Read and follow the user documentation for all additional equipment.



### **Electrical safety**

- The fixture is IP65-rated. It may be installed in outdoor locations temporarily for entertainment lighting purposes. It is not designed to be installed permanently outdoors or in any environment where there is a presence of salt or other corrosive substance. Do not submerge the fixture or any part of it. Do not expose any part of the fixture to high-pressure water or air jets.
- Ensure that cables arrive at connectors from below. Ensure that water cannot pool around connectors.
- Use only a source of AC mains power that complies with local building and electrical codes and has both overload and ground fault (earth fault) protection.
- Ensure that the fixture is electrically connected to ground (earth).

- Disconnect the fixture from AC mains power before carrying out any installation or maintenance work and when the fixture is not in use.
- Disconnect the fixture from power immediately if any seal, cover, cable, connector or other component is damaged, defective, deformed or showing signs of overheating. Do not reapply power until the fixture has been repaired and made safe by a technician authorized by GLP.
- Check that all power distribution equipment, cables and connectors are in perfect condition, rated for the electrical requirements of all connected devices, suitable for their application and suitable for the installation environment.
- Use only Neutrik PowerCON TRUE1 TOP-type cable connectors for AC mains power input at the fixture's Mains IN connector and for relaying AC mains power from one fixture's Mains OUT (Thru) connector to another fixture's Mains IN connector.
- Use minimum 14 AWG or 1.5 mm<sup>2</sup> power input and relay cables that are minimum 16 A-rated and temperature-rated to suit the application. In the USA and Canada the cables must be UL-listed, type SJT or equivalent. In the EU the cables must be type H05VV-F or equivalent for indoor use in a dry or wet environment or type H07RN-F or equivalent for outdoor use or use in a location where the temperature may fall below 5° C / 41° F.
- Do not connect devices to power in a chain if the total maximum current draw of all the devices in the chain when added together will exceed the current rating of any cable or connector used at any point in the chain. The supplied power input cord (cable) is rated as follows:
  - US power cord: 16 A, 14 AWG, UL-listed, E304117, SJT, length 4.9 ft.
  - EU power cable: 16 A, 1.5 mm<sup>2</sup>, H05VVF-F, length 1.5 m. This cable is suitable for indoor use in dry or wet locations. If you use the fixture in an outdoor location or in any location where the ambient temperature can fall below 5° C / 41° F, replace the power cable with a 16 A-rated, 3 x 1.5 mm<sup>2</sup> H07RN-F type cable.Do not connect more than two (2) impression X5 IP Bar 1000 fixtures linked together in a chain to power at 100-120 V, 60 Hz.  
Do not connect more than four (4) impression X5 IP Bar 1000 fixtures linked together in a chain to power at 200-240 V, 50 Hz.
- The voltage and frequency at the Mains OUT socket are the same as the voltage and frequency applied to the Mains IN socket. Only connect devices to the Mains OUT socket that accept this voltage and frequency.



### **Fire safety and protection from burns**

- Do not operate the fixture if the ambient temperature (Ta) exceeds 45° C (113° F).
- The surface of the fixture can become hot during operation. Avoid contact by persons and materials. Do not install the fixture in a location where there is a risk

of accidental contact. Allow the fixture to cool for at least 20 minutes before handling

- Keep the fixture well away from flammable materials.
- Keep all combustible materials (e.g. fabric, wood, paper) at least 0.2 m (8 in.) away from the fixture.
- Ensure that there is free and unobstructed airflow around the fixture.
- Do not illuminate surfaces within 1 m / 3.3 ft. of the fixture. The light output from the fixture is powerful enough to cause burns or fire in illuminated objects at very close range.
- Do not place any optical components other than impression X5 IP Bar 1000 accessories from GLP onto the front of the fixture.
- Do not stick filters, masks or other materials onto the fixture unless they are supplied or approved by GLP. Do not block the light output in any way. The front surface becomes hot during operation and can melt or ignite objects that are in contact with the surface. Ensure that the front surface is clean and unobstructed at all times in order to prevent a fire hazard and prevent damage to the fixture.
- The fixture's optical components can focus the sun's rays, creating a risk of fire and damage. Do not expose the front of the fixture to sunlight or any other intense light source, even from an angle.



### **Eye safety**

- The impression X5 IP Bar 1000 is classified as a Risk Group 2 lighting fixture according to EN 62471 at a distance of 1 m (3.3 ft.). Possibly hazardous radiation emitted. Do not stare into the light output from the fixture. May be harmful to the eyes.
- Do not look at the fixture's light output with optical instruments or any device that may concentrate the light output.
- Make sure that persons near to or working on the fixture are not looking directly into the light output when the fixture lights up suddenly. This can happen when power is applied, when the fixture receives a DMX signal, or when certain control menu items are selected.
- Provide well-lit conditions to reduce the pupil diameter of anyone working on or near the fixture.



### **Strobe safety**

- Flashing light, particularly at 5 - 30 Hz, may cause seizures in persons with photosensitive epilepsy. Do not use strobe effects for extended periods.



- Comply with local regulations on the use of strobe lighting and notify the public in advance with highly visible warning signs when strobe effects are used.
- If a seizure occurs, stop using strobe effects. Seek professional medical help. Note the time that the seizure starts and finishes. Call emergency medical help urgently if the seizure lasts more than five minutes, if it is the person's first seizure, or if the person is injured. While waiting for help to arrive, protect the affected person from injuring themselves on hard or sharp objects. If necessary, move the person to a safe place. Lay them on their side with their head supported to prevent it from hitting the floor. Loosen any tight clothing around their neck. Do not use force to hold the person or restrict their movements. Do not put anything in their mouth, including your fingers.



### ***Installation safety and protection from personal injury***

- Installation must be performed by qualified personnel only and carried out in accordance with applicable regulations such as DIN VDE 0711-217.
- The fixture is not portable when installed.
- Ensure that the supporting structure and installation hardware used can hold at least ten times the weight of the load that they support.
- Fasten the fixture to a structure or surface only as directed in this manual and only with hardware that is specifically designed and rated for its purpose. Do not use a safety cable as the primary means of support. Check that installation hardware is in perfect condition. Fasteners must be steel grade 8.8 strength or better. Rigging clamps must be half-coupler type that completely encircle the rigging truss chord.
- If the fixture is installed in a location where it could cause injury or damage if it falls, install as directed in this manual a safety cable or similar secondary attachment that will hold the fixture if a primary attachment fails. The secondary attachment must be approved by an official body such as TÜV as a safety attachment for the weight that it secures, it must comply with EN 60598-2-17 Section 17.6.6, and it must be able to support a static suspended load that is ten times the weight that it secures.
- If the fixture is installed in a location where it may be exposed to forces such as wind pressure, vibration or movement, make sure that the installation can withstand these forces. Monitor weather forecasts constantly. Take down the installation immediately if there is any risk of weather conditions that could destabilize the installation.
- Check that all covers and items of rigging hardware are secure before using the fixture. Do not operate the fixture with missing or damaged covers, shields or any optical component.
- Restrict access below the work area and work from a stable platform whenever installing, servicing or moving the fixture.

- If the fixture becomes damaged, stop using it immediately and disconnect it from power. Do not attempt to use a fixture that is obviously damaged.
- Do not modify the fixture in any way not described in its user documentation.
- Install genuine GLP parts only.

## 2. Avoiding damage to the fixture

**Important! Follow the directions in this section carefully, or the fixture may suffer damage that is not covered by the product warranty.**

### General precautions

- Do not drop the fixture or expose it to mechanical stress.
- Protect the LCD display and control panel from shocks, or they may suffer damage that is not covered by the product warranty.
- Clean optical components only as directed in the fixture's user documentation. Oils, solvents, and other chemicals commonly used for cleaning can damage the lens coatings and surfaces.
- Use only original spare parts. Do not make any structural modifications to the fixture, or you will void the product warranty.
- Create loose cable bends only. Do not subject connectors to bending forces or allow connectors to bear the weight of long lengths of cable.

### Avoiding damage from light sources and heat

- Do not point the front of the fixture towards the sun or other strong light sources. Strong light can cause internal damage to the fixture, melting components or starting an internal fire within seconds.



Figure 1. Avoiding damage from light sources

- Damage can occur whether the fixture is powered on or off. See Figure 1. Damage can also occur if the light hits the front of the fixture at an angle: the fixture does not need to be pointing *directly* at the sun or other light source.
- To avoid problems from strong light sources:
  - Do not expose the front of the fixture to sunlight or any other strong light source.
  - In outdoor applications during daylight, make sure that the front face of the fixture is shielded or points away from the sun at all times, even when the fixture is not in use.
  - Do not aim other high-powered lighting fixtures directly at the fixture.

- Do not operate the fixture in ambient temperatures outside the range -10° C (14°F) to 45° C (113°F).
- Allow free airflow around the fixture.

### ***Avoiding damage from dust and airborne particles***

- Carry out regular visual inspections of the fixture to make sure that there is no accumulation of dirt, especially on the front of the fixture and around air vents.
- If cleaning is necessary, follow the instructions in 'Service' on page 22.

### ***Transportation and storage***

- Transport the fixture in its original packaging to protect it from damage caused by shocks during transportation.
- Release the fixture's tilt lock before putting the fixture in its flightcase or other protective container for transportation. Before closing the flightcase, check that the protective liner in the flightcase will hold the head and protect it from shocks.
- Store the fixture in a dry location when not in use.

### 3. impression X5 IP Bar 1000 overview

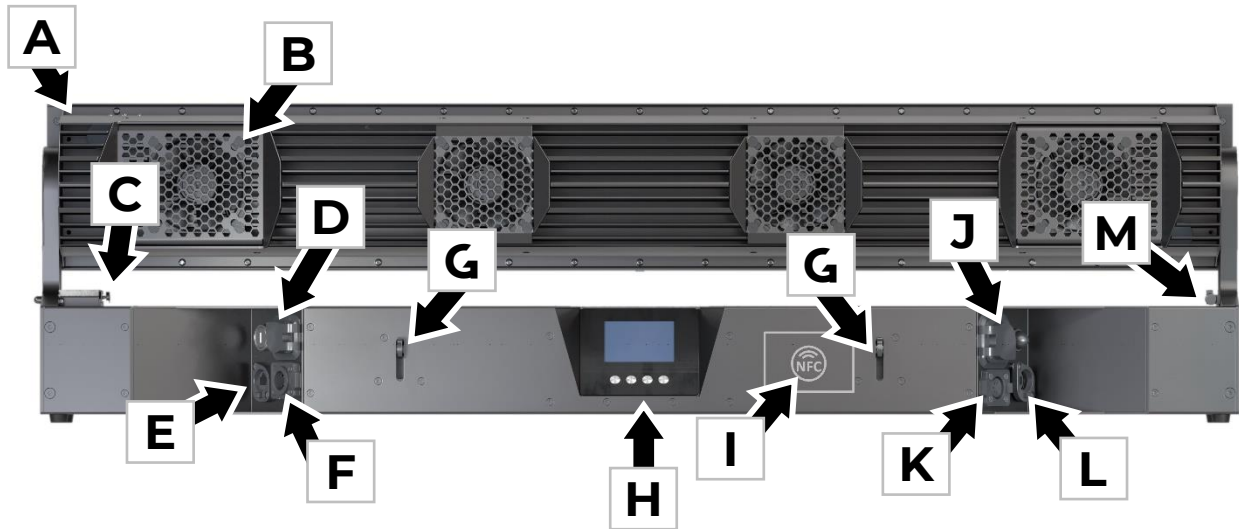

**Figure 2. impression X5 Bar IP 1000 overview**

- A – Head**
- B – Air vent (x 4)**
- C – Alignment pins button**
- D – AC mains power IN (Neutrik powerCON TRUE1 TOP)**
- E – Neutrik etherCON port A for future control options, fail-safe\***
- F – DMX IN (5-pin XLR)**
- G – Safety cable attachment points (retractable)**
- H – Control panel with backlit display**
- I – NFC Sensor**
- J – AC mains power THRU (Neutrik powerCON TRUE1 TOP)**
- K – Neutrik etherCON port B for future control options, fail-safe\***
- L – DMX THRU (5-pin XLR)**
- M - Tilt lock**

*\*Additional control options are in preparation for a future firmware release*

## 4. Features

The impression X5 IP Bar 1000 from GLP can be used temporarily in outdoor locations for entertainment purposes and in dry locations in permanent and temporary installations. Fixtures can be placed on or fastened to a level surface, or they can be suspended from a suitable structure as directed in this manual.

Power and data can be daisy-chained for ease of installation, and multiple fixtures can be lined up to give an unbroken line of pixels using the retractable alignment pins that are built into the fixture.

### **User Manual**

This Quick Start and Installation Manual gives a very basic overview of control options and functions. See the impression X5 IP Bar 1000 User Manual available for download from [www.glp.de](http://www.glp.de) for full details of control, pixel layout, etc.

### **Tilt lock**

**Important!** Before transporting the fixture in its original packaging or in a flight case, release the tilt lock and make sure that the head is supported to prevent it from moving.

The impression X5 IP Bar 1000 has a tilt lock that can be used to prevent the head from moving while the fixture is being carried. The tilt lock also lets you immobilize the head during cleaning or while installing optical accessories on the front of the fixture.

See Figure 3. The tilt lock button is located on the back of the head. To engage the tilt lock:

1. Check that power to the fixture is shut down.
2. Move the head into the upright position, facing away from the fixture base.
3. Slide the tilt lock button towards the yoke and into the **Lock** position to engage it.
4. Release the tilt lock by sliding it away from the yoke and into the **Unlock** position before reapplying power to the fixture.



**Figure 3. Tilt lock button**

## 5. Installation



**Warning!** Read 'Safety' starting on page 5 for important safety information that you must understand before you install or operate the fixture. Install impression X5 IP Bar 1000 fixtures only as described in this chapter, or you may create an installation that is unsafe.

It is the installer's responsibility to provide a stable, secure supporting structure that is suitable for the environment and application and that meets all applicable codes and legal requirements. Note the requirement to secure lighting fixtures with safety cables in temporary installations.

### ***Mounting options***

An impression X5 IP Bar 1000 fixture may be installed in one of the following ways:

1. Standing horizontally on a horizontal surface.
2. Fastened to a rigging truss or similar structure at any angle using the supplied brackets and two or more rigging clamps (optional accessories).

### ***Securing the fixture with a safety cable***

If a fixture can cause injury or damage if it falls you must secure it with at least one secondary attachment such as a safety cable that will hold it if the primary means of attachment fails. The safety cable must be approved for the weight that it secures. In multiple installations, each fixture must have its own safety cable. To secure an impression X5 IP Bar 1000 fixture with a safety cable:

1. Obtain a safety cable that is approved for the weight of the fixture and rigging hardware that it will secure.
2. Loop the cable around a secure anchoring point such as a truss chord or fixed structure so that it will catch the fixture if a rigging clamp fails. Take up as much slack as possible in the safety cable (by looping it more than once around the truss chord, for example).
3. See Figure 1 on page 13. Open one of the retractable safety cable attachment eyelets marked **G** in Figure 1 and fasten the safety cable to it.
4. If there is any danger that the fixture may swing dangerously from the safety cable if a primary attachment fails, open the second retractable safety cable eyelet also marked **G** in Figure 1 and add a second safety cable as described above, fastening it to this second eyelet.
5. Check that the fixture will now be caught safely by the safety cable if a primary attachment fails..

### **End-to-end alignment**

The impression X5 IP Bar 1000 features alignment pins that let you line up fixtures perfectly end-to-end to create an unbroken line of pixels. To use the alignment pins:

1. See Figure 4. The alignment pin release button is located on the base of the fixture.
2. Slide the release button outwards to move the alignment pins out of the fixture.
3. Engage the pins in the corresponding holes in the right-hand end of the next fixture to line the two fixtures.

*Important! The pins are for alignment purposes only, do not apply a load to them.*

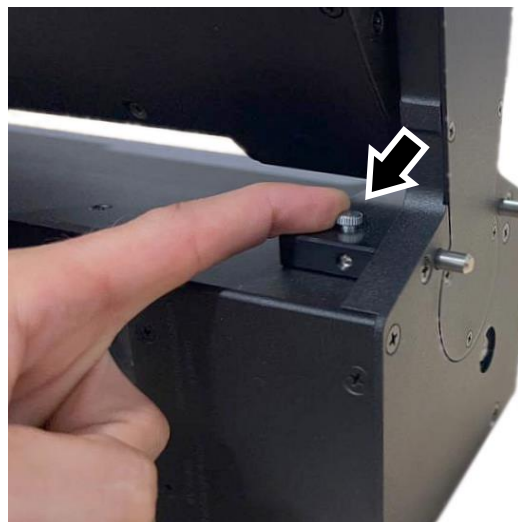
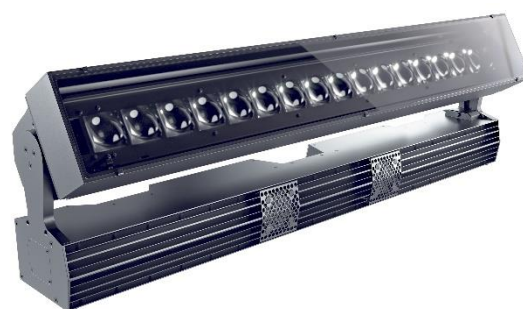

**Figure 4. Alignment pin release button**

### **Standing the fixture on a horizontal surface**

To place an impression X5 IP Bar 1000 fixture standing horizontally on a stable horizontal surface:

1. Stand the fixture on the small feet in the fixture's base as shown in Figure 5. Make sure that it is safe and secure, and that it will not present a danger of tripping or falling.
2. If there is any danger of injury or damage if the fixture falls from the surface, secure it with a safety cable as described in 'Securing the fixture with a safety cable' on page 15.



**Figure 5. X5 Bar IP 1000 placed on a horizontal surface**

### **Installing on a rigging truss or similar structure**

You can suspend an impression X5 IP Bar 1000 fixture from a rigging truss or pipe using the two brackets that are supplied with the fixture and rigging clamps that are available from GLP as optional accessories.

If you are going to install the fixture hanging vertically downwards from a horizontal rigging truss or pipe, you can fasten it to the truss using G-clamps. If you are going to install the fixture in any other orientation or if the rigging truss is not horizontal, you must use half-coupler-type clamps that completely surround the truss chord or pipe.

Rigging clamps must be approved for the weight that they will support.



To install the impression X5 IP Bar 1000 on a rigging truss or pipe:

1. Check that the truss or pipe is secure and can safely hold ten times the weight that it will support.
2. See Figure 6. Bolt at least one rigging clamp securely to each of the two rigging brackets **A** that are supplied with the fixture using high-tensile steel screws or bolts and self-locking nuts with washers passed through the slots **B** or central hole **C** in the rigging brackets.

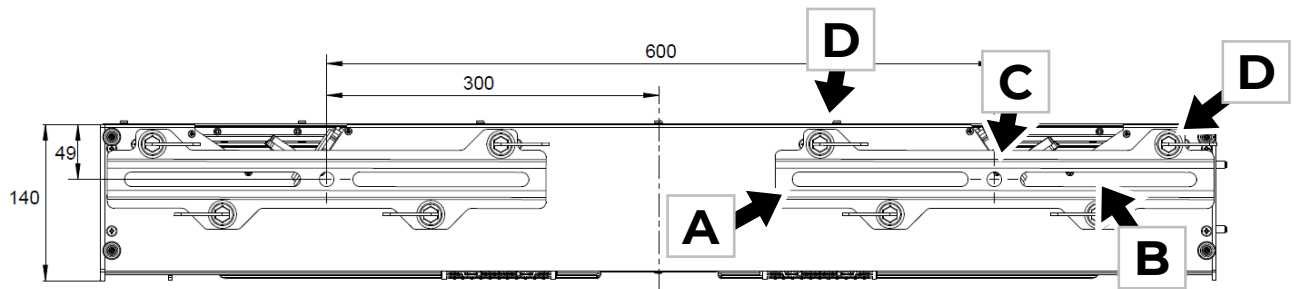

**Figure 6. Rigging brackets**

3. Fasten the two brackets **A** to the bottom of the base using four quarter-turn fasteners **B** per bracket. Turn each fastener a full 90° to lock it.
4. Hold the fixture up to the truss and use the rigging clamps to fasten the fixture securely onto the truss chord.
5. If there is any risk that the fixture will cause injury or damage if it falls, secure it with a safety cable that is approved for the weight of the fixture, rigging hardware, cables etc. as described in 'Securing the fixture with a safety cable' on page 15.

## 6. AC mains power



**Warning!** Read 'Safety' starting on page 5 for important safety information that you must understand before you install or operate the fixture.

Check that all cables and connectors are suitable for the installation environment and application (see recommendations in 'Avoiding damage to the fixture' on page 11).

Cables used for power input and for relaying power to other fixtures must meet the requirements listed under 'Electrical safety' on page 6.

### **Power input cable**

The impression X5 IP Bar 1000 is supplied with a power cord (power cable) with a Neutrik powerCON TRUE1 TOP connector for AC mains power input.

### **Connecting to power**

The AC mains power supply must include a connection to ground / protective earth. It must be protected against ground / earth leakage and overload. The fixture's internal auto-sensing power supply accepts AC power at 100-240 V, 50/60 Hz. Do not connect the fixture to power at any other voltage or to an external dimmer.

The impression X5 IP Bar 1000 does not have a power ON/OFF switch. Power is applied to the fixture as soon as the power cable becomes live.

The impression X5 IP Bar 1000 has a 3-conductor Neutrik powerCON TRUE1 TOP Mains IN power input socket that accepts AC power from a TRUE1 TOP female cable connector. Although TRUE1 connectors support hot-plugging, it is still good practice to shut down power to power cables before connecting them to fixtures.

To connect the fixture to power:

1. If possible, shut down power to the power input cable.
2. Note the position of the keys and keyways on the TRUE1 TOP power cable connector and Mains IN socket and align them with each other carefully. Insert the cable connector into the socket and twist clockwise to lock. Do not use force. If the connector feels excessively stiff, remove it and check that it is lined up correctly.
3. Before applying power to the power cable, check that nobody is looking directly into the front of the fixture and check that there is no risk of collision if the head tilts without warning.

To disconnect the fixture from power, pull the latch on the cable connector outwards to release it, then twist the connector counterclockwise and pull to remove it from the socket.

### **Installing power connectors**

If you need to replace the cord cap / power plug on the supplied power cord / power input cable, check that the cord cap / plug is rated minimum 250 V, 16 A, that it has a connection to ground / earth and that it has an integral cable grip. Follow the cord cap / plug manufacturer's assembly instructions.

If you need to install a Neutrik powerCON TRUE1 TOP connector on a power cable, follow the instructions given in the Support area of the Neutrik website at [www.neutrik.com](http://www.neutrik.com).

Respect the color coding used in the supplied power cable and in your local mains power wiring system. US and EU systems use the color coding shown below:

	Live or L	Neutral or N	Ground / Earth or ⊕
<b>US system</b>	Black	White	Green
<b>EU system</b>	Brown	Blue	Yellow/green

### **Connecting multiple fixtures to power in a chain**

You can connect fixtures to power in a daisy-chain to simplify your power circuit layout.



**Warning!** Do not connect more than two (2) impression X5 IP Bar 1000 fixtures in total to power in one chain at 100-120 V, 60 Hz. Do not connect more than four (4) impression X5 IP Bar 1000 fixtures in total to power in one chain at 200-240 V, 50 Hz.

The power input cable supplied with the fixture is rated 16 A maximum. Add together the maximum current draw ratings of all the devices that you intend to connect to power in a daisy chain and do not create a chain with a total maximum current draw of more than 16 A, or you will create a risk of fire and electric shock.

To connect fixtures to power in a chain:

1. Obtain power relay cables that have male and female Neutrik powerCON TRUE1 TOP connectors. Cables must be minimum 14 AWG or 1.5mm<sup>2</sup>, rated minimum 16 A and suitable for the environment and application.
2. Connect the power input cable to the Mains IN socket of the first fixture.
3. If you are operating the fixture on 100-120 V, 60 Hz AC mains power, you can connect maximum one fixture to the mains THRU socket (giving a maximum of 2 fixtures total connected together in a chain) using a power relay cable. Do not connect any devices to the Mains THRU socket of the second fixture.

If you are operating the fixture on 200-240 V, 50 Hz AC mains power, you can connect maximum three fixtures to the mains THRU socket (giving a maximum of 4 fixtures total connected together in a chain) using power relay cables. Do not connect any devices to the Mains THRU socket of the fourth fixture.

## 7. Connecting to DMX data

Check that all cables and connectors are suitable for the installation environment and application (see recommendations in 'Avoiding damage to the fixture' on page 11).

The impression X5 IP Bar 1000 supports the USITT DMX 512A control data signal protocol. Additional control protocol options are in preparation for a future firmware release. The fixture also supports RDM (ANSI E1.20 Remote Device Management) over the DMX link.

The X5 IP Bar 1000 has two 5-pin XLR connectors for IN and THRU connections on a DMX data link using standard DMX protocol. We recommend the use of digital 110 Ohm DMX cable with original Neutrik 5-pin TOP-type XLR connectors.

If you would like advice with planning and installing a DMX link, your GLP supplier will be happy to provide assistance.

## 8. Starting and stopping operation



**Warning!** Before you apply power to the impression X5 IP Bar 1000 or operate it after a blackout, make sure that nobody is looking directly into the front of the fixture and that there is sufficient clearance for the head to tilt safely.

The fixture's TRUE1 TOP mains power input connector supports hot-plugging, and connecting and disconnecting a live power cable is an option, especially if you need to shut down power urgently, but it is still good practice to shut down power to the AC mains power circuit before connecting and disconnecting power cables.

To start operation, check that nobody is looking into the front of the fixture and that there is no risk of collision of the head tilts without warning, then apply power to the AC mains power circuit.

To stop operation, shut down power to the AC mains power circuit.

### ***Transportation and storage***

We strongly recommend that you transport the fixture either in a flightcase or in its original packaging to protect it from damage during transportation. The product warranty does not cover damage caused by abnormal shocks during transportation and handling.

When the fixture is not installed, disconnect it from power and store it in a dry location.

## 9. Service



**Warning!** There are no user-serviceable parts inside the fixture. Any service operation that requires removal of a cover must be performed by a professional service technician with the tools, skills, and personal protective equipment to maintain high-powered lighting equipment safely and efficiently.

### ***Installing optical accessories***

The impression X5 IP Bar 1000 has channels in the front of the head for the installation of optical accessories. Impression X5 IP Bar 1000 accessories such as a soft diffuser and an asymmetrical beam shaper are available from GLP.

To install a filter:

1. Place the fixture on a work surface with the head upright.
2. See Figure 7. Lift up the two quick-release clips (arrowed) on both sides of one end of the head and slide the accessory into the channels in the head.
3. Release the clips and check that the locking mechanism holds the filter securely and that the accessory cannot slide out of the channels.
4. To remove an accessory, lift up the quick-release clips and slide the accessory out of the channels in the head. Release the clips.



**Figure 7. Front cover retaining clip**

### ***Cleaning***

impression X5 IP Bar 1000 fixtures require occasional cleaning to prevent the buildup of dust, dirt, and residue from atmospheric effects. Failure to keep the fixture clean will significantly reduce light output and may cause heat buildup and damage that is not covered by the product warranty. Regular cleaning will ensure maximum performance and reliable operation.

The cleaning schedule depends on the operating environment. Check fixtures regularly for signs of dirt buildup.

You can clean the fixture using a soft cloth slightly dampened with a household or automotive glass cleaning product. Do not apply pressure to the clear front or display on the back of the fixture, as you may scratch these surfaces.

### ***GLP Service and Support***

Contact information for the nearest GLP Service and Support is available online at [www.glp.de/en/service](http://www.glp.de/en/service), by email at [info@glp.de](mailto:info@glp.de), or by telephone at the following numbers:

- GLP Germany: +49 (7248) 927 19-55
- GLP N. America: +1 818 767-8899
- GLP UK: +44 1392 690140
- GLP Asia: +852 (3151) 7730
- GLP Nordic: +46 737 57 11 40

## 10. Technical specifications

### **Optics and photometrics**

Light source: 18 x 40 W RGLB LEDs

LED lifetime: 50 000 hrs. approx. to > 70% luminous output

Output lenses: 18 x square lenses: 48 x 48 mm with 980 x 120 mm aperture

#### **Total luminous output, RGLB**

##### **Wide zoom**

Half-peak (50%): 4120 lm

Field (10%): 7010 lm

Cutoff (3%): 7360 lm (3%)

##### **Medium zoom**

Half-peak (50%): 3520 lm

Field (10%): 5760 lm

Cutoff (3%): 5920 lm

##### **Narrow zoom**

Half-peak (50%): 2240 lm

Field (10%): 3850 lm

Cutoff (3%): 4040 lm

Max. peak luminous intensity, RGLB: 492000 cd @ narrow

#### **Zoom range**

##### **Minimum zoom angle**

Half peak (50%): 5.5° x 4.9°

Field (10%): 9.8° x 7.6°

Cutoff (3%): 12° x 8.5°

##### **Maximum zoom angle**

Half peak (50%): 29° x 28°

Field (10%): 48° x 49°

Cutoff (3%): 60° x 60°

Zoom ratio: 1:13

Default white point: 6500 K

Optional white points: 8000 K; 5600 K; 4200 K; 3200 K

iQ.Gamut (color spaces): Full; Rec.709; Rec.2020; DCI P3.65

CRI: >90 @ 8000 K; 90 @ 6500 K; 85 @ 3200 K

TLCI: 90 @ 6500 K; 75 @ 3200 K

TM-30-15: Rf/Rg: 87/105 @ 6500 K; Rf/Rg: 85/110 @ 3200 K

### **Effects**

Color mixing: RGLB

Color mixing control options: RGB, RGLB, x,y

Pixel control: 18 x pixels with overall, segment or independent control

Zoom: See *Optics and photometrics* above

Virtual color wheel: 64 Lee-referenced color presets, HIS color spin

Color temperature control: Variable 10 000 – 2500 K, fine-tuning via color mix

Color quality control: High Output (HO) or High Quality (HQ) with de-saturation

Magenta-green shift: Continuously variable

Tungsten simulation options



Dimmer: 0 – 100% continuous 16-bit electronic dimming, choice of three dimming curves

Shutter: Regular and random strobe and pulse effects, instant open and blackout, random pixel strobe

Two-layer FX engine with over 50 static and over 50 dynamic pixel patterns, each with up to 64 pattern steps; random pixel; pattern-to-pattern crossfade effects; pattern step transition effects

Tilt: 195°, 16-bit control

Performance modes for adjusting the speed of all mechanical movements: Normal (balanced), Fast and Smooth

### **Control and programming**

Control systems: DMX (USITT DMX512-A), RDM (ANSI/ESTA E1.20), LumenRadio CRMX, GLP iQ.Mesh (Art-Net and sACN in preparation)

DMX control modes: 6

DMX channel footprint: 20, 33, 48, 84, 63 or 81 depending on mode

Standalone operation: One captured scene

Setting and addressing: Onboard control panel with backlit graphic display, DMX, RDM, iQ.Service app

NFC

FPO Port (Flexible Protocol Option) with LumenRadio CRMX Module

Firmware update: DMX Link via Dprog, GLP iQ.Mesh, Fixture2Fixture Push

DMX compliance: USITT DMX512

RDM compliance: ANSI/ESTA E1.20

RDM Manufacturer ID: 0x676C (GLP German Light Products GmbH)

RDM Device Model ID: 65

### **Installation**

Options: Standing on horizontal surface, mounted on rigging truss or pipe at any angle

Rigging hardware attachment: Quarter-turn fastener points for two brackets (supplied), each with 4 x quarter-turn fasteners

Operating position: Any

Minimum distance to combustible materials: 0.2 m (8 in.)

Minimum distance to illuminated surfaces: 1 m (3.3 ft.)

Installation environment: Temporary outdoor installation, temporary or permanent indoor installation

Secondary attachment: 2 x retractable safety cable attachment eyelets

### **Electrical**

AC mains power: 100-240 V nominal, 50/60 Hz

Power supply unit: Auto-ranging electronic switch mode

Maximum power consumption, all LEDs at 100% output: 750 W at 250 V

EU Energy Efficiency Class: B

EU Energy Efficiency Index: 0.87

Typical energy consumption: 677 kWh per hour

#### **Maximum permitted number of fixtures daisy-chained to power**

2 x impression X5 IP Bar 1000 total @ 100-120 V, 60 Hz

4 x impression X5 IP Bar 1000 total @ 200-240 V, 50 Hz

### **Connections**

AC mains power IN and THRU: Neutrik powerCON TRUE1

Standard DMX data link IN and THRU: 5-pin XLR

Art-Net and sACN data link IN and THRU: Neutrik etherCON, failsafe link integrity (in preparation)

### **Construction**

Ingress protection rating: IP65

Fixture housing: High-impact flame-resistant thermoplastic, aluminum alloy, steel

Color: Black

Optical filter slide-in system (no tools required)

Tilt lock

Integrated multiple fixture alignment system

### **Thermal**

Cooling: Combined forced air, convection

Minimum ambient operating temperature: -10° C (14° F)

Maximum ambient operating temperature: 45° C (113° F)

Storage temperature range: -20° C (-4° F) to 50° C (122° F)

Max. total heat dissipation: 2600 BTU/hr.

### **Included items**

Power cable with Neutrik powerCON TRUE1 mains input connector

2 x brackets for rigging clamps or surface mounting

### **Dimensions and weight**

Height, head straight up (including rubber feet, without bracket): 317 mm / 12.5 in.

Height, head horizontal (including rubber feet, without bracket): 269 mm / 10.6 in.

Additional height with bracket: 30 mm (1.2 in.)

Width across yoke: 1000 mm / 39.4 in.

Depth, head straight up: 144 mm / 5.7 in.

Min. center-to-center distance: 170mm / 6.7 in., 1000 mm / 39.4 in.

Weight without brackets, without accessories: 27.2 kg (60 lbs.)

## 11. Dimensions

### *impression X5 IP Bar 1000*

All dimensions are in millimeters

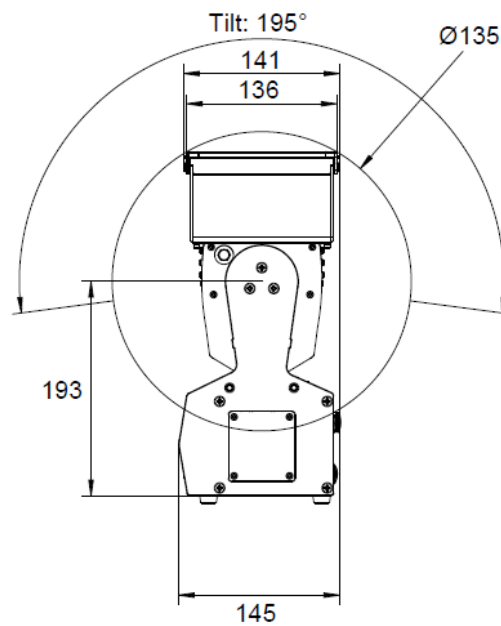
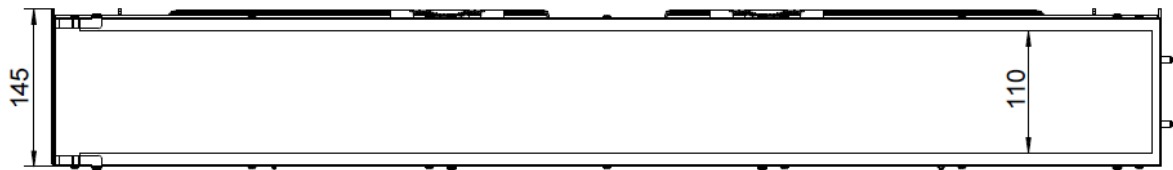
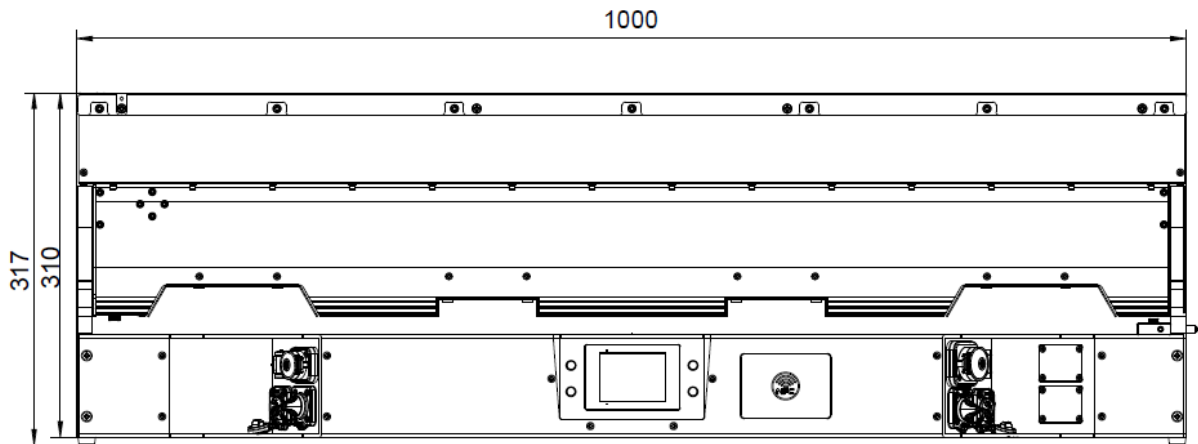



-GLP-